

Ned Kelly Bike Racks® (NK-2000)



Galvanised finish



Black powder coat finish

Features



- Each rail provides storage for a single bike
- Suits bikes with full length mud guards
- Available in galvanised or powder coat over mild steel
- Provides the ability to lock the main frame and one wheel
- Support prongs with protective coating prevent damage to rim
- Can be used with custom framing – no wall needed

Dimensions

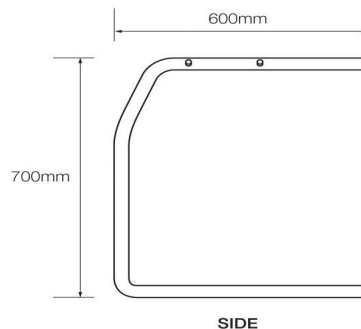

Specifications

Material options

- Galvanised
- Powder coat over mild steel
- Stainless steel*

Fixing options

- Bolt on to wall
- Fixed to support framing

Recommended fasteners – wall

- Dynabolts (M8 x 40mm)
- Shear Nut security fasteners

Recommended fasteners – framing

- Bolt and nut (M10 x 60mm)
- Tek screws

Dimensions

125mm [w] x 700mm [h] x 600mm [d]

* Pre-order only

Locking points

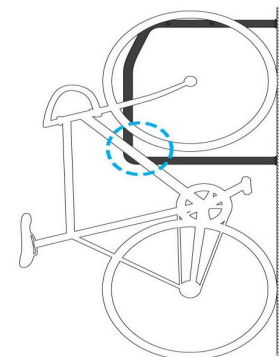

Fixing options

Fix to a wall using 4x fasteners or Shear Nuts

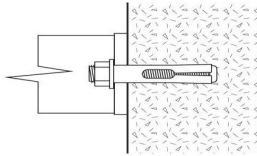

Shown with M8 x 40mm fastener

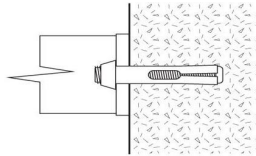

Shown with M8 x 40mm Shear Nuts

Fix to a frame using 4x bolts or Tek Screws

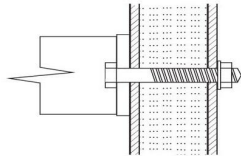

Shown with M10 x 60mm Bolt, Washer & Nut

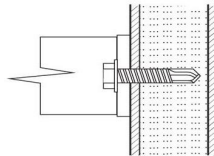

Shown with Tek Screw

Layout guidelines

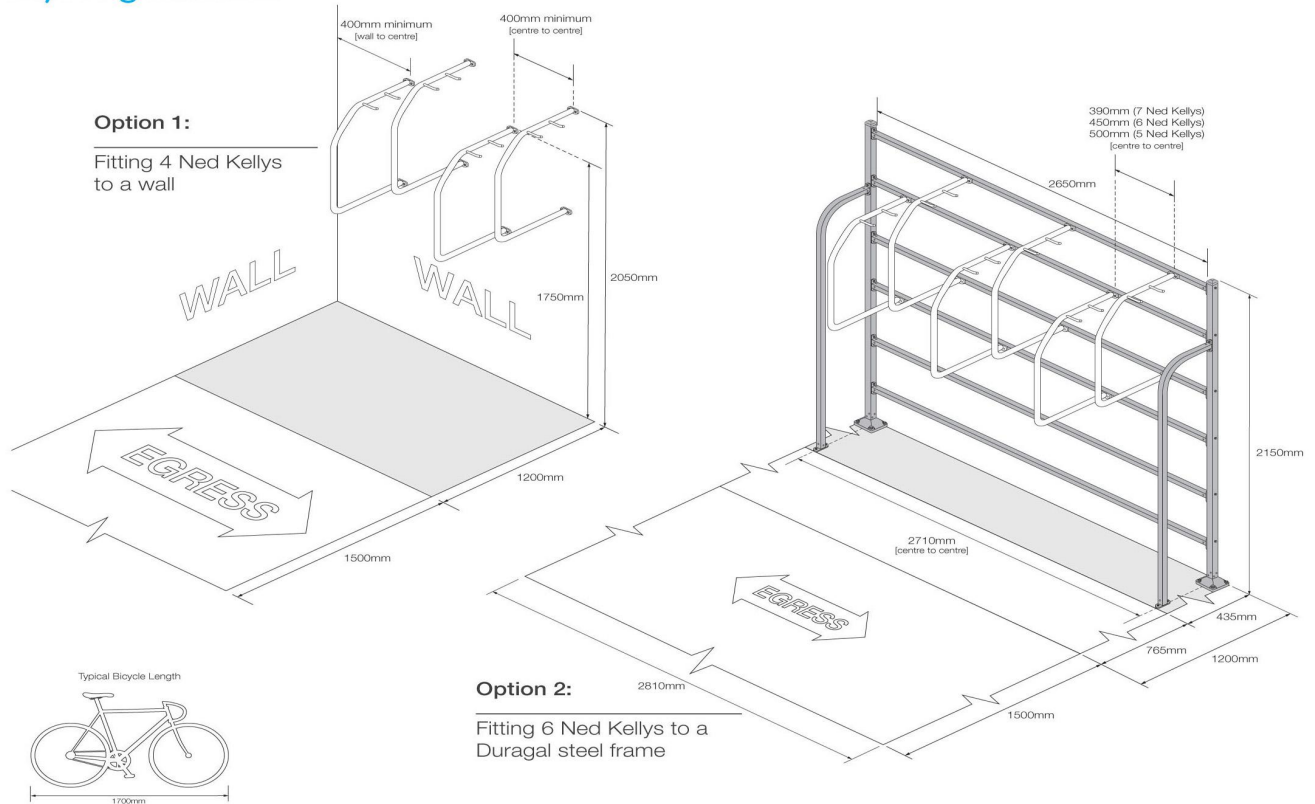

Ned Kelly Bike Racks® (NK-2000)